

A novel positioning method for optical automatic inspection of an LCD assembly process

Chern-Sheng Lin^{a,*}, Su-Chi Chang^a, Yun-Long Lay^b, Mau-Shiun Yeh^c, Chi-Chin Lin^d

^a*Department of Automatic Control Engineering, Feng Chia University, Taichung, Taiwan*

^b*Department of Electronic Engineering, National Chinyi University of Technology, Taiwan*

^c*Chung-Shan Institute of Science & Technology, Lung-Tan, Tao-Yuan, Taiwan*

^d*Department of Computer Science and Information Engineering, National Taiwan University, Taiwan*

Received 29 August 2008; accepted 18 December 2008

Abstract

In this paper a new marker alignment method is applied to the fabrication process of FPC positioning bonding, and sample comparison technology applied to the combined fabrication process of TFT-LCD. After the first linear regression method, filtration process, and second linear regression calculation, the central coordinate of the positioning marker can be obtained. The compensation method carries out sample point mapping compensation through parallelism or perpendicularity between the middle line and boundary line. This method can effectively avoid the positioning error produced by flaws in image taking process or poor image quality. This positioning method not only applies to the single image, but also could precisely position two images. In the future, it is expected this positioning method can be combined with positioning machine, and conduct positioning online.

© 2009 Elsevier GmbH. All rights reserved.

Keywords: TFT-LCD; Linear regression calculation; Compensation method

1. Introduction

The series of LCD (liquid crystal display) production covers each of the procedures: baking, curing, rubbing, dry cleaning, combination rubbing and dry cleaning, spacer spraying, gasket seal printing and dispensing, combination alignment, assembly, and liquid crystal filling [1–5]. An LCD assembly sequence consists of adhesive dispensing (required for sealing the panels), location and alignment of one plate with respect to the other and exposure to cure the adhesive and bond the two plates together [6,7].

This LCD positioning system is implemented for LCD testing, gluing, and bonding. When testing, it is necessary to adjust the image rotation angle in advance for the remaining testing procedures. When two LCD panels are glued together, the position alignment must be very precise. Most factories design four marks onto the corners of the LCD panels to detect alignment errors and make the alignment easier [8–10]. When an error occurs in the image alignment procedure, the usual skew detection technique cannot solve this problem and manual procedure is used as the correction process.

In the fabrication process of thin-film transistor (TFT) liquid crystal displays, OLB (outer lead bonding) engineering (see Fig. 1) is applied to fasten PCB to the terminal of TCP. It is joined to the anisotropic conductive film (ACF) vertically using high temperature

*Corresponding author. Tel.: +886 4 24519951.
E-mail address: lincs@fcu.edu.tw (C.-S. Lin).

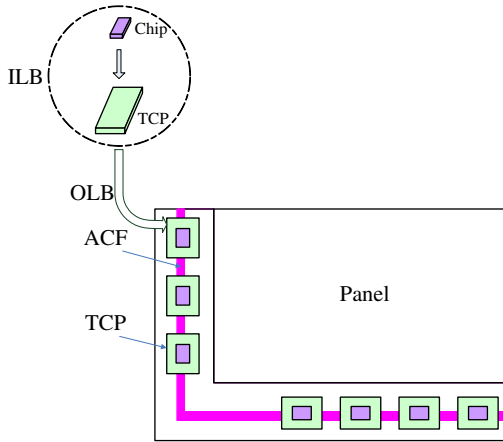

Fig. 1. Outer lead bonding process.

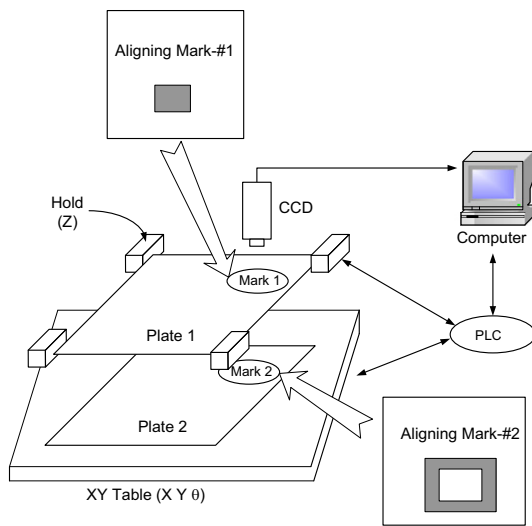

Fig. 2. Positioning system of market image.

and high pressure, which would fracture and deform the conducting particles inside ACF to form a conducting circuit.

Before bonding, the PCB panel and LCD panel need to be positioned. The common positioning system is shown in Fig. 2. The PC base with PLC control machine aligns the rectangular marker of the two panels. The video camera captures the rectangle marker image of PCB panel and LCD panel, and transmits the images to the computer. After analysis, the computer transmits the alignment result to PLC to proceed to movable positioning. Rectangle marker can be divided to four segments and computed with linear least-squares regression individually. Linear least-squares regression for optical measurement has been widely proposed and implemented by CMM (coordinate measurement machines) equipped with camera or vision inspection. This kind of method has been in place for many years and widely employed by industries [11,12]. But the individually computed result of linear least-squares

regression cannot guarantee four segments be perpendicular each other. So we must treat four segments as a whole with a algorithm which is novel and advanced from the existing methods.

This study presents a new rectangle marker alignment method to be applied to the fabrication process of FPC positioning bonding, and sample comparison technology to be applied to the combined fabrication process of TFT-LCD. According to the fabrication process, this study first used novel positioning method to assist the machine completing ACF bonding. The result of this study showed the accuracy of the efficient precise combination, sampling method, and positioning can be maximized.

2. Solution of central point of rectangle linear regression

Figs. 3–5 show the diagrams of using a rectangle as the sample of linear regression to obtain the central point. After the camera captures the rectangular images, and transmits them to the computer, the program first searches the four corner points of the rectangle S_1, S_2, S_3 and S_4, \dots . The 4 points are used as the base points, and with program thresholds, to search for all points that form this boundary line within the area. In Fig. 3, four point groups of $P_{1i}(x_i, y_i), P_{2j}(x_j, y_j), P_{3k}(x_k, y_k)$ and $P_{4z}(x_z, y_z)$ can be obtained from blocks Z_1, Z_2, Z_3 and Z_4 . “ i ” is the total number of boundary points in area Z_1 ; “ j ” is the total number of boundary points in area Z_2 ; “ k ” is the total number of boundary points in area Z_3 ; “ z ” is the total number of boundary points in area Z_4 (see Fig. 4).

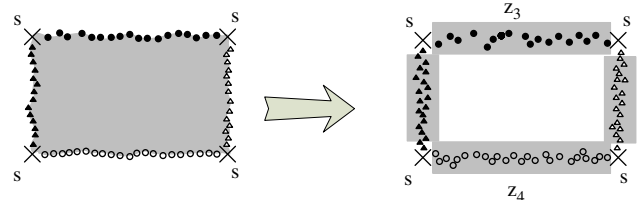

Fig. 3. Four point groups of the rectangle image.

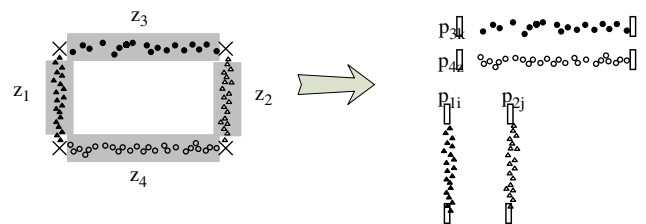

Fig. 4. Total number of boundary points within the area of the rectangle image.

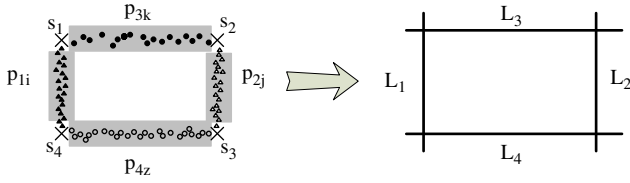

Fig. 5. Central point based on linear regression of rectangle.

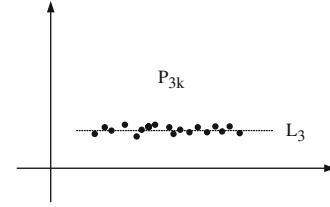

Fig. 6. Diagram of linear regression of horizontal point group \$P_{3k}\$.

To obtain the information of the four line segments that form the rectangle, the program carries out linear regression against the four point groups. Linear regression of point group \$P_{1i}(x_i, y_i)\$ derives line segment \$L_1\$; linear regression of point group \$P_{2j}(x_j, y_j)\$ derives line segment \$L_2\$; linear regression of point group \$P_{3k}(x_k, y_k)\$ derives line segment \$L_3\$; linear regression of point group \$P_{4z}(x_z, y_z)\$ derives line segment \$L_4\$ (see Fig. 5).

After the program obtains equations of the four sides of the rectangle, the central coordinate of the rectangle can be positioned by calculation. Since the four sides are already known, the deflection angle of the rectangle can be derived. This method can obtain more data on the rotational angle than the centroid method.

2.1. Linear regression of horizontal line

Based on the basic equation of linear regression, the point data of \$P_{3k}(x_k, y_k)\$ and \$P_{4z}(x_z, y_z)\$ in the point group of each horizon is inputted. Take the line segment derived for \$P_{3k}\$ by line segment \$L_3\$ as an example, as shown in Fig. 6, the straight line equation of \$L_3\$ shall be \$\tilde{y}_3 = a_3 + b_3x_{3k}\$. The sum of the square error is

$$S = \sum_{m=1}^k (y_{3m} - \tilde{y}_3)^2 \tag{1}$$

Substitute \$\tilde{y}_3 = a_3 + b_3x_{3k}\$ into the above equation

$$S = \sum_{m=1}^k (y_{3m} - (a_3 + b_3x_{3m}))^2 \tag{2}$$

Take differential of \$S\$ against \$a_3\$ and \$b_3\$, and make it zero to obtain the values of \$a_3\$ and \$b_3\$.

$$\begin{cases} \frac{\partial S}{\partial a_3} = \sum_{m=1}^k 2(y_{3k} - (a_3 + b_3x_{3k}))(-1) = 0 \\ \frac{\partial S}{\partial b_3} = \sum_{m=1}^k 2(y_{3k} - (a_3 + b_3x_{3k}))(-x_{3k}) = 0 \end{cases} \tag{3}$$

Then derive

$$\begin{cases} ka_3 + b_3 \sum_{m=1}^k x_{3k} = \sum_{m=1}^k y_{3k} \\ a_3 \sum_{m=1}^k x_{3k} + b_3 \sum_{m=1}^k x_{3k}^2 = \sum_{m=1}^k x_{3k}y_{3k} \end{cases} \tag{4}$$

which is

$$\begin{cases} a_3 = \frac{(\sum_{m=1}^k y_{3k})(\sum_{m=1}^k x_{3k}^2) - (\sum_{m=1}^k x_{3k})(\sum_{m=1}^k x_{3k}y_{3k})}{k(\sum_{m=1}^k x_{3k}^2) - (\sum_{m=1}^k x_{3k})^2} \\ b_3 = \frac{k(\sum_{m=1}^k x_{3k}y_{3k}) - (\sum_{m=1}^k x_{3k})(\sum_{m=1}^k y_{3k})}{k(\sum_{m=1}^k x_{3k}^2) - (\sum_{m=1}^k x_{3k})^2} \end{cases} \tag{5}$$

Extend Eq. (5) to each line segment to be used indiscriminately as Eq. (6)

$$\begin{cases} a_M = \frac{(\sum_{m=1}^N y_{Mm})(\sum_{m=1}^N x_{Mm}^2) - (\sum_{m=1}^N x_{Mm})(\sum_{m=1}^N x_{Mm}y_{Mm})}{N(\sum_{m=1}^N x_{Mm}^2) - (\sum_{m=1}^N x_{Mm})^2} \\ b_M = \frac{N(\sum_{m=1}^N x_{Mm}y_{Mm}) - (\sum_{m=1}^N x_{Mm})(\sum_{m=1}^N y_{Mm})}{N(\sum_{m=1}^N x_{Mm}^2) - (\sum_{m=1}^N x_{Mm})^2} \end{cases} \tag{6}$$

\$M\$ is the serial number of the boundary point group; \$N\$ is the value of total points in the boundary point group. Substitute the boundary points into the above Eq. (6) and the linear equation is:

$$L_M : \tilde{y}_{Mm} = a_M + b_Mx_{Mm}, \quad m = 1 \sim N \tag{7}$$

2.2. Linear regression of vertical line

From the relation between horizontal line and vertical line, it is known if the linear equation of the horizontal line is \$y = a + bx\$, the line segment slope of vertical level is \$-1/b\$, as shown in Fig. 7. Take point group \$P_{1i}(x_i, y_i)\$ of each vertical line segment as an example, first the average of this point group along the coordinate \$X\$ and \$Y\$ is derived to obtain average point coordinate (\$X_{mean}\$ and \$Y_{mean}\$), and then convert the coordinate of the point group to:

$$\begin{cases} x'_i = y_i \\ y'_i = x_i \end{cases} \tag{8}$$

Eq. (8) is converting the coordinates of the original sampling point \$x_i\$ and \$y_i\$ by vertical \$90^\circ\$ with the original point as center. Original sample vertical point group is converted to horizontal state. When the new sample point group \$P'_{1i}(x'_i, y'_i)\$ after coordinate conversion is substituted into Eq. (8), \$b'_1\$ is obtained. Therefore, the slope of original vertical sample point group is

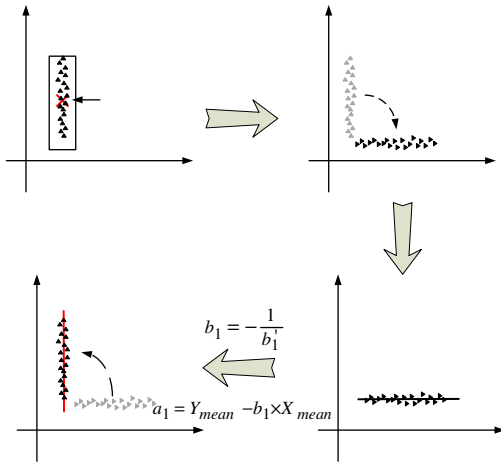

Fig. 7. Diagram of linear regression of vertical point group P_{1i} .

$b_1 = -1/b'_1$. When the average point coordinate (X_{mean}, Y_{mean}) is substituted into Eq. (9), intercept a_1 of line segment is obtained.

$$a_1 = Y_{mean} - b_1 \times X_{mean} \tag{9}$$

The central point coordinate of market image is obtained by linear regression. A set of filtration and compensation system is presented to avoid a shortage of sample points in the boundary point group, which causes the line segment to produce error after regression because of bad image taking or two overlapping images. Filtration system is to select points close to the line segment before linear regression. Compensation system is to strengthen sample points in the boundary point group. The following is a detailed introduction of this system.

2.3. Filtration process

The straight line equation calculated by linear regression is compared with its sample point. If the distance between the sample point and straight line equation of linear regression is larger than the pre-set threshold, the sample point is to be eliminated. After all sample points are evaluated, new straight line equation of linear regression is calculated with the rest of the sample points to obtain a precise middle line.

The line segment L_3 is set to be the straight line equation calculated after the first linear regression against point group $P_{3k}(x_k, y_k)$. In the point group, some sample points are comparatively far from line segment L_3 due to problems in image treatment or the marker itself. If it is removed from point group and the second linear regression is carried out, the precise line segment L_3 can be obtained. First, the correcting action is done by pre-set threshold. L'_3 is obtained after the second calculation of linear regression based on the remaining sample points.

2.4. Compensation process

Generally, for the whole image to be positioned, after the first linear regression method mentioned above, filtration process, and second linear regression calculation, central coordinate of positioning marker can be obtained. However, a shortage of sample points in point group because of poor image quality would lead to errors in line segment calculated by regression, as shown in Fig. 8. Fig. 8 shows line segment L_1 as an example. If the number of sample point “ k ” in point group $P_{3k}(x_k, y_k)$ is not enough, slope of line segment will not be precise after regression.

To solve the error caused by the noise of sampling points, the compensation method is presented by this study to increase sample points. The compensation method carries out sample point mapping compensation through parallelism or perpendicularity between the middle line and boundary line. As shown in Fig. 9, which presents the rectangular map as the sample, the L_3 is perpendicular to L_1 and L_2 and in parallel with L_4 . Based on this characteristic, the point coordinate of sample point group P_{1i} which forms L_1 and sample point group P_{2j} which forms L_2 are turned by 90° and point group P_{4z} which forms L_4 maps to the corresponding position by -90° rotation. As a result, the total sample points of point group P_{3k} are increased.

The compensation method of rectangular positioning marker is performed with the benchmark point coordinate in rotation process. For example, in Fig. 10, point group P_{1i} which forms L_1 is taken as the benchmark. The first step is to turn point group P_{3k} 90° clockwise, with coordinate P_1 of the boundary points as the original point, to join the position facing point group P_{1i} . The original number of point group “ i ” is changed to $i' = i + k$. Then, the number of sample

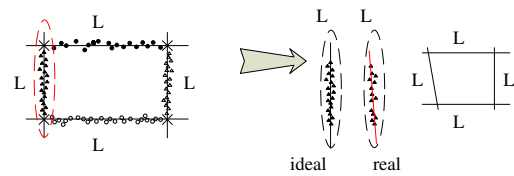

Fig. 8. Sketch map of linear regression error of rectangular marker.

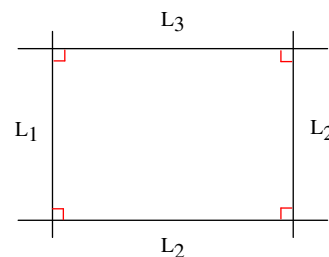

Fig. 9. Diagram of line segments perpendicular to each other.

points which form L_1 has increased to k .

$$\begin{aligned} X'_{p3k} &= X_{p3k} \cos \frac{\pi}{2} + Y_{p3k} \sin \frac{\pi}{2} \\ Y'_{p3k} &= -X_{p3k} \sin \frac{\pi}{2} + Y_{p3k} \cos \frac{\pi}{2} \end{aligned} \quad (10)$$

where X_{p3k} , Y_{p3k} , X'_{p3k} , Y'_{p3k} are the X -axis and Y -axis coordinate of the point group P_{3k} before and after transformation.

The first step is to turn point group P_{4z} 90° counter-clockwise with coordinate P_4 of boundary points as the original point to join the position facing point group P_{1i} . The original number of point group i' is changed to $i' = i' + z$. Then, the number of sample points which form L_1 has increased to $k + z$.

$$\begin{aligned} X'_{p4z} &= X_{p4z} \cos \frac{-\pi}{2} + Y_{p4z} \sin \frac{-\pi}{2} \\ Y'_{p4z} &= -X_{p4z} \sin \frac{-\pi}{2} + Y_{p4z} \cos \frac{-\pi}{2} \end{aligned} \quad (11)$$

where X_{p4z} , Y_{p4z} , X'_{p4z} , Y'_{p4z} are the X -axis and Y -axis coordinate of the point group P_{4z} before and after transformation.

The third step is to map the point group P_{2j} by translation with the central point as the original point to join the position facing point group P_1 . The original number of point group i' is changed to $i' = i' + j$. Then, the number of sample points which form L_1 has increased to $k + z + j$.

$$\begin{aligned} X'_{p2j} &= X_{p2j} - b \\ Y'_{p2j} &= -Y_{p2j} \end{aligned} \quad (12)$$

where X_{p2j} , Y_{p2j} , X'_{p2j} , Y'_{p2j} are the X -axis and Y -axis coordinate of the point group P_{2j} before and after translation transformation with b distance.

The action of sample point compensation is completed. The total number of sample points of point group $P_{1i'}$ is increased from i to $k + i + j + z$. When the last linear regression is performed on the point group

after regression, the straight line equation of L_1 , L_2 , L_3 and L_4 can be obtained through vertical and displacement relation.

3. Experimental results and discussion

The result of rectangular positioning can be researched and discussed in two parts. First, there is no overlapping between two rectangles; second, there is overlapping between two rectangles. Fig. 11 shows the result of positioning of two rectangles with no overlapping. The picture is so complicated that the central coordinate cannot be obtained with the centroid method. Therefore, the equation merely shows the result of the central point coordinate calculated by the linear regression method. The green point in Fig. 11(a) and (c) is the central point of the outer pane, and the red point is the central point of the solid rectangle. Fig. 11(b) and (d) shows the line segments after calculating the linear regression of two rectangles. Therefore, the central point of rectangle of Fig. 11(a) and (c) is obtained by calculating the line segments of Fig. 11(b) and (d).

Fig. 12 discusses the state of two rectangles with overlapping, including the solid rectangle covering the top right corner of the pane (Fig. 12(a) and (b)), solid rectangle covering the right side of the pane (Fig. 12(c) and (d)), solid rectangle covering the underside of the pane (Fig. 12(e) and (f)), and solid rectangle covering the top left corner of the pane (Fig. 12(g) and (h)). It shows rectangular positioning through linear regression method can precisely position images.

Fig. 12(b) shows only a small area of the pane is covered by the solid rectangle, therefore, the line segment after linear regression is not affected because of limited coverage. However, because there is excessive

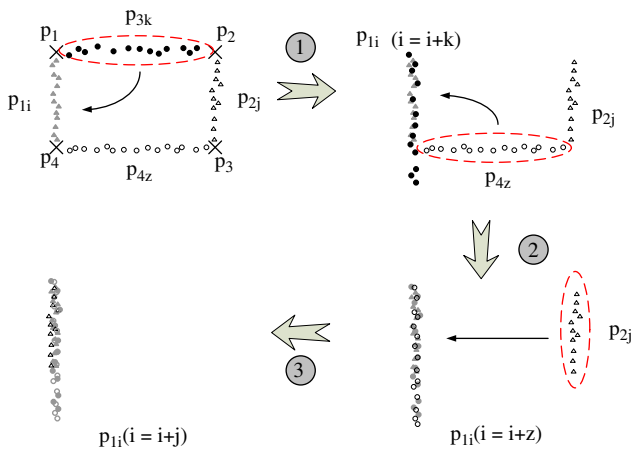

Fig. 10. Diagram of compensation of rectangular marker.

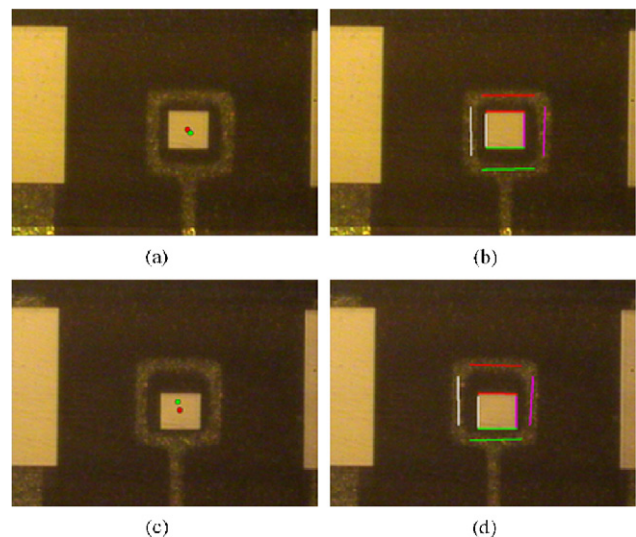

Fig. 11. Positioning result of rectangles with no overlapping.

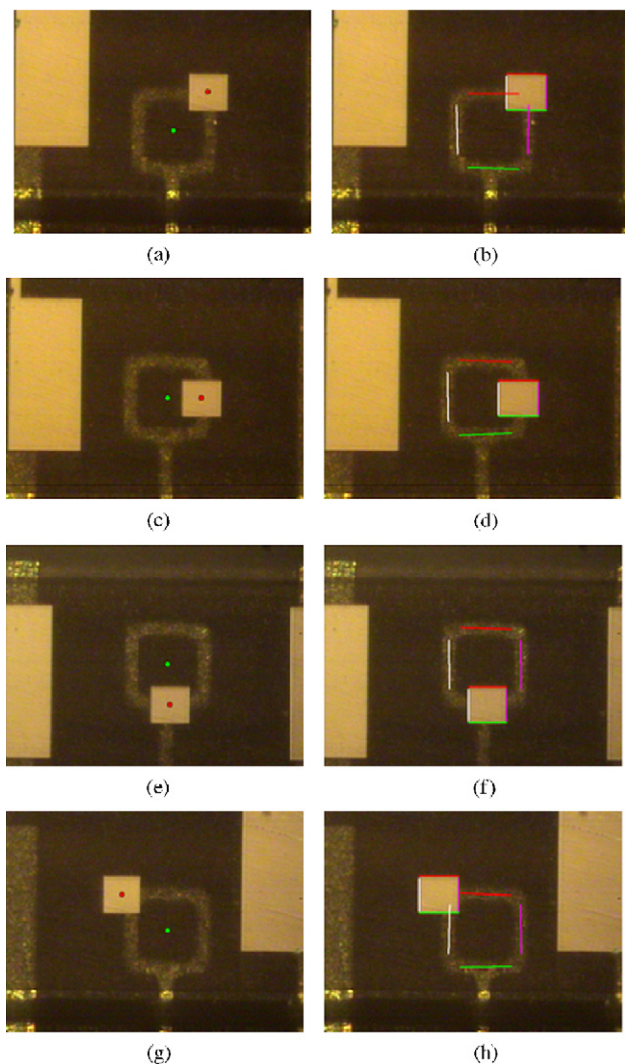

Fig. 12. Positioning result of rectangles with overlapping.

data in Fig. 12(d), (f) and (h) covered by the solid rectangle, the line segment of regression cannot be calculated. Therefore, the central point of the pane is calculated through the other three line segments and the result is shown in Fig. 12(c), (e) and (g).

The test of double rectangles is to move the coordinate of double rectangles towards the top left side for 10 times. Total moving distance is 500 μm . Each figure's positioning is calculated after movement to obtain the difference between the measurement result and real movement. Stabilities under different states are compared with one another. The positioning result of solid rectangle is the same with figure movement. Since the picture of solid rectangle is comparatively clear without disturbing information, the positioning result is precise. When the solid rectangle falls in the middle of the pane, the error is larger. When it overlaps on the pane, the error is smaller. Total error is within 2 μm (Fig. 13).

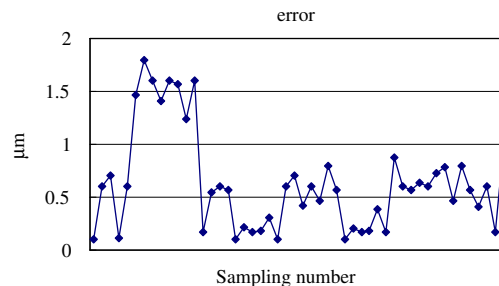

Fig. 13. Result of positioning process.

4. Conclusion

This study proposed a novel positioning method with a rectification and compensation system to efficiently position double rectangles with or without overlapping. The result showed regardless of overlapping, the linear regression method can calculate the result and produce the correct result because of overlapping. If one side is short of data because of overlapping, the line segment can be shown through the compensation method. The central coordinate of double rectangles can be calculated.

This study proposed a novel positioning method with a complete structure. This method can effectively avoid the positioning error produced by a flaw in the image taking process or poor image quality. This positioning method not only applied to a single image, but could also position two images precisely. In the future, it is expected this positioning method can be combined with a positioning machine, and conduct positioning online. Results of marker alignment will applied under different situations to set up a complete automatic online positioning system.

Acknowledgment

This work was sponsored by the National Science Council under Grant number NSC 96-2221-E-035-028-MY3.

References

- [1] M.H. Wu, C.S. Fuh, C.Y. Chen, Defect inspection and analysis of color filter panel, *Images Recogn.* 6 (2) (2000) 74–90.
- [2] C.S. Lin, W.Z. Wu, Y.L. Lay, M.W. Chang, A digital image-based measurement system for a LCD backlight module, *Opt. Lasers Technol.* 33 (7) (2001) 523–529.
- [3] H. Murase, V.V. Vinod, Fast visual search using focused color matching—active search, *Syst. Comput. Jpn.* 31 (9) (2000) 81–88.
- [4] K. Nakashima, Hybrid inspection system for LCD color filter panels, in: 10th International Conference on

- Instrumentation and Measurement Technology, Hamamatsu, 1994. pp. 689–692.
- [5] C.S. Lin, Y.C. Liao, Y.L. Lay, K.C. Lee, M.S. Yeh, High-speed TFT LCD defect detection system with genetic algorithm, *Assembly Automat.* 28 (1) (2008) 69–76.
- [6] C.S. Lin, C.W. Tsai, Y.C. Lu, C. Tsou, S.C. Chang, Automatic inspection of the width and gap of etching transistors in TFT-LCD panels using sub-pixel accuracy estimation, *Int. J. Adv. Manuf. Technol.* 35 (2007) 127–134.
- [7] J. Cho, C.S. Lin, B.J. Jan, C.H. Lin, N.C. Chang, An opto-electrical method for measuring the gap of LCD glass plates, *Opt. Laser Technol.* 37 (8) (2005) 623–630.
- [8] C.S. Lin, Y.L. Lay, C.C. Huan, H.C. Chang, T.S. Hwang, An image-based LCD positioning system utilizing the modified FHT method, *Optik* 114 (4) (2003) 151–160.
- [9] C.A. Glasbey, An analysis of histogram-based thresholding algorithms, *CVGIP: Graph. Models Image Process.* 55 (1993) 532–537.
- [10] B. Gatos, S.J. Perantonis, N. Papamarkos, Accelerated Hough transform using rectangular image decomposition, *Electron. Lett.* 32 (8) (1996) 730–732.
- [11] D.M. Tsai, J.I. Tzeng, Dimensional and angular measurements using least squares and neural networks, *Int. J. Adv. Manuf. Technol.* 13 (1) (1997) 56–66.
- [12] Q. Liu, C.C. Zhang, H.P.B. Wang, On the effects of CMM measurement error on form tolerance estimation, measurement, *J. Int. Meas. Confed.* 30 (1) (2001) 33–47.